

IC Specifications

- IC Protocol:ISO/IEC 15693
- ISO Typical Operating Frequency:13.56MHz
- Chip:SLI-X
- User Memory:896 bits
- Operating Temperature:-40°C/+85°C
- Storage Temperature:-55°C/+125°C

Antenna Design

- Aluminum Etching/30 μm
- Substrate: PET/38 μm
- Aluminum Etching/10 μm

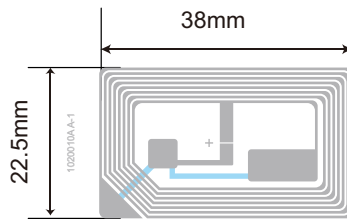

Label Layout and Dimensions

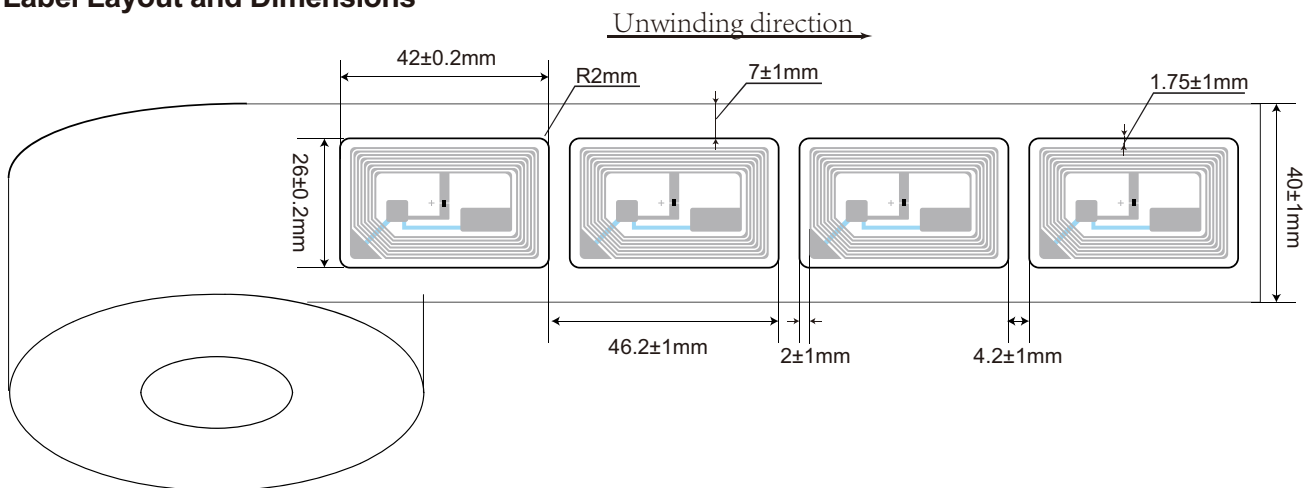

Label Composition

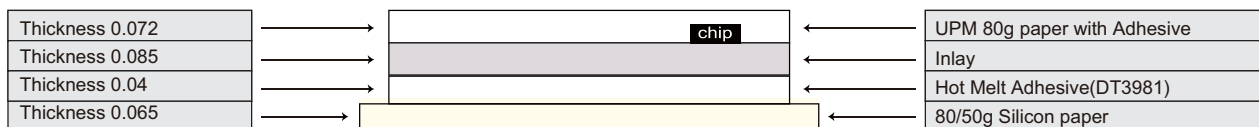

Packaging

	1,000 pcs/roll with 3" core 1 meter leading silicon paper at the beginning and ending of roll
	1 roll/inner case 160*160*45mm(TBD)
	10 inner cases/master ctn 350*180*255mm(TBD)